



Assembly Instructions

ELITE 3M ROUND PARASOL

(13109001 - DOVE) (13108001 - DARK GREY) (13105001 - SAGE)

PLEASE RETAIN THIS DOCUMENT ALONG WITH YOUR PROOF OF
PURCHASE FOR FUTURE REFERENCE

Congratulations on your recent purchase of your beautiful Hartman product. We hope it brings you bountiful special moments with friends and family for many years to come. Please follow these simple steps to build your Hartman product.

TOP TIPS:



- Please read these instructions carefully before assembly
- Although assembly only requires 1 person it is advised that a second person be present to help place into position when fully assembled.
- Simply clean the umbrella canopy with a soft brush and mild detergent.
- Do not machine wash or machine dry.
- Do not iron.
- Air-dry the canopy thoroughly in an open position before storing for extended periods of time.

IMPORTANT INFORMATION

- **IMPORTANT!** Always close/put down the parasol when not in use. The parasol's intended use is for a sun shade only. Do not use or assemble the parasol in heavy winds, rain, thunderstorms or if it's snowing. In these weather conditions, we recommend to fold down or disassemble the parasol. Disassemble by following the setup steps in this manual.
- **IMPORTANT!** The parasol must be secured in place using a parasol base. Make sure the ground is level and firm.
- **IMPORTANT!** If the crank gets too hard to turn, check if the rope has come off the pulley. If you continue to turn the crank, the rope or crank handle could break.
- **IMPORTANT!** Placing the parasol over or near a swimming pool can cause premature fading of the canopy.
- **WARNING:** To prevent damage to parasol, facing the canopy against the wind.
 - i. Do not assemble the parasol on sandy, muddy or loose soil.
 - ii. Keep children and pets away while setting up the parasol.
 - iii. Children must be supervised around the parasol.
 - iv. This parasol is for outdoor use only.
 - v. Do not light any fires under or near the parasol!
 - vi. This parasol is primarily intended to be used as a sunshade and not as wind protection.

For replacement or lost spare parts please go to <http://faq.hartmanuk.co.uk/spares/>
Should you have any queries about your furniture your first point of contact should be the retailer from whom you purchased your product.

PARTS LIST

Component's				
Parts List	Parts Picture	Description	Q'ty	Component no.
A		Frame with canopy and solar panel	1	13109001A 13108001A 13105001A
B		Bottom pole	1	13109001B 13108001B 13105001B
C		Cover	1	13109001C 13108001C 13105001C

Step 1

Remove the foam blocks for protection at the top of the parasol. Then turn the solar panel counter clockwise. Find the plug at the top of the parasol. Insert the plug into the socket under the solar panel, as shown. Put the solar panel on the top of the parasol and hide the plug and wire inside the groove at the top of parasol. Then turn the solar panel clockwise.

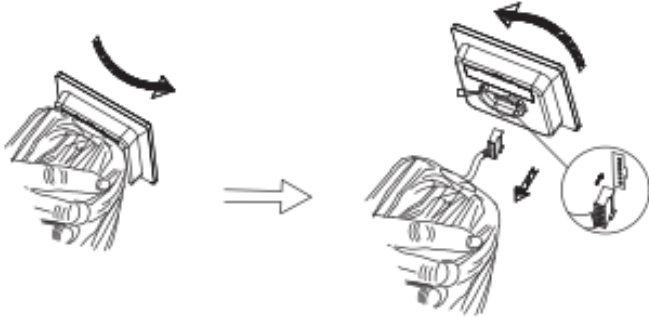

Step 2

Press the spring-button of the part (A) while inserting the part (B) pole until it locks in place (the spring-button should pop into the hole in the pole).

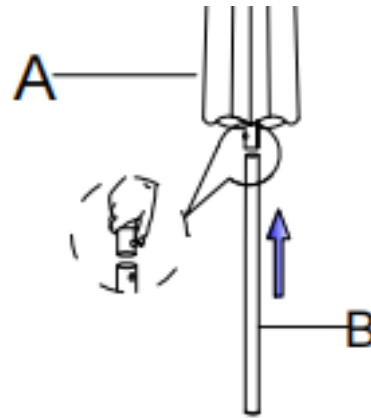

Step 3

We recommend that you secure the parasol to one parasol base (sold separately).

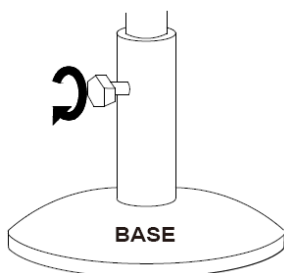

Step 4

Unfold the crank handle downward, then turn it in clockwise direction to open the parasol canopy, opposite direction to close the canopy. TO CLOSE THE PARASOL IT MUST BE IN THE UPRIGHT POSITION.

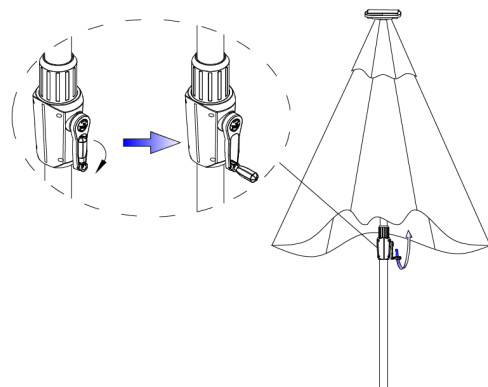

Step 5

Tilt the parasol to the desired angle by turning the collar in a clockwise direction, opposite direction to erect the parasol.

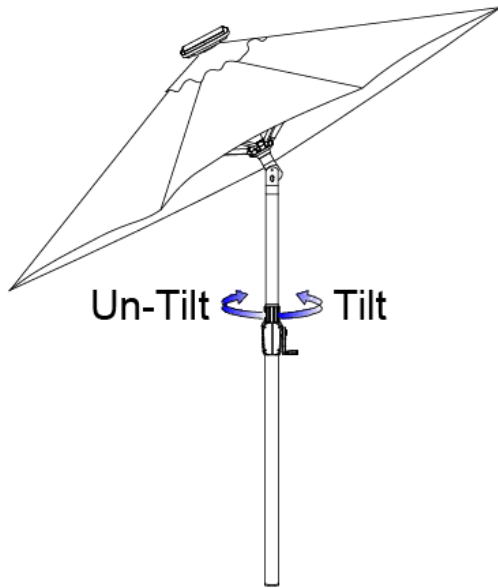

Step 6

To operate the lights, turn the switches (located on the end of one rib) to the ON ('I') position. Ensure both switches are set to the OFF ('O') position when the lights are not being used. **IMPORTANT:** If the lights are accidentally left on during the day the batteries will NOT charge and the lights will not operate at night.

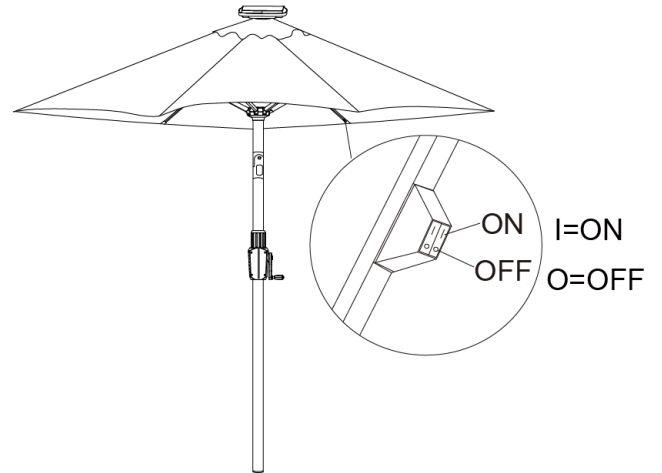

Step 7

To fold the crank handle, pull it to the right and fold upwards.

